

VAMP 259

Line manager for distance and line differential protection

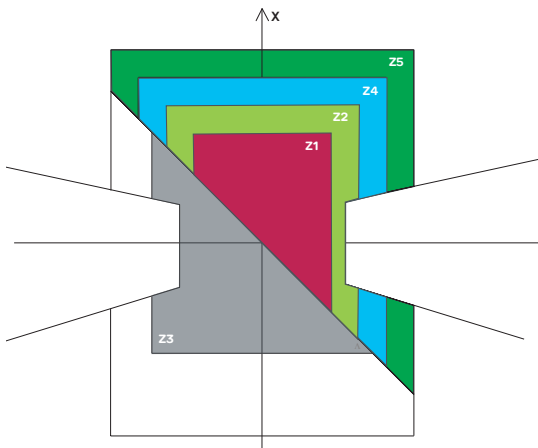

The VAMP 259 line manager is used for applications where combined protection, remote and local control, measurement, power quality, alarming and status indication functions are needed. The manager is suitable for full-scheme distance protection and it incorporates line differential functions usually required for the protection of subtransmission cables and overhead lines.



MAIN CHARACTERISTICS

- Medium voltage/sub transmission line differential protection (87L)
- Distance protection (including full scheme) with 30 independent distance elements for 6 measuring systems (21/21E)
- Pilot channel communication functionality for various protection schemes (85)
- Complete set of time and instantaneous overcurrent, overvoltage, undervoltage, and frequency protection functions
- Sensitive earth fault protection functions which are suitable for compensated, isolated and solidly grounded networks
- Programmable protection stages
- Auto-reclose function
- Synchrocheck function
- Switch-onto-fault(SOTF) functionality
- Digital input support for Trip Circuit Supervision
- Selectable nominal DI activation voltage
- Frequency stage df/dt (ROCOF)
- Fault value, alarm led display, event buffer, blackout data and disturbance recording storage in non volatile memory
- Native solution for IEC61850 communication with support for GOOSE messages
- Removable / interchangeable communication modules for connecting the relay to various system communication solutions and medias

Line distance protection

The distance protection function calculates the impedance $Z = U/I$ for each of the distance elements. If impedance is inside the tripping zone (normally presented in R-X plane), the distance function operates. For short circuit protection there are 15 independent elements and earth fault protection. The distance protection function calculates impedances in each of the fault loops continuously thus giving the distance protection high precision and accuracy for demanding sub-transmission applications.

The distance protection's zones implement polygonal characteristics. Additionally the function supports load blocking area (i.e. load encroachment area) settings which are possible to enable for each zone individually.

VAMP 259 distance protection is applicable for power systems where the grounding (earthing) star point can be solid or low resistance grounded. Resonant-earthed via Petersen coil or isolated can be protected with sensitive directional earth fault protection.

The distance protection tripping can operate with or without the use of tele protection schemes. For example, when POTT (Permissive Overreaching zone Transfer Trip) or PUTT (Permissive Underreaching zone Transfer Trip) is required it can be achieved via any DI/DO signals or pilot channel communication (85). At least one DI/DO pair is required per direction.

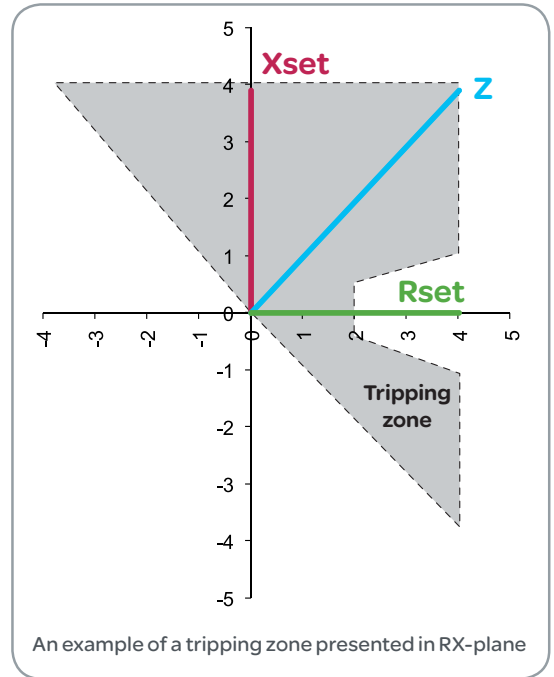

Distance protection application polygonal characteristics

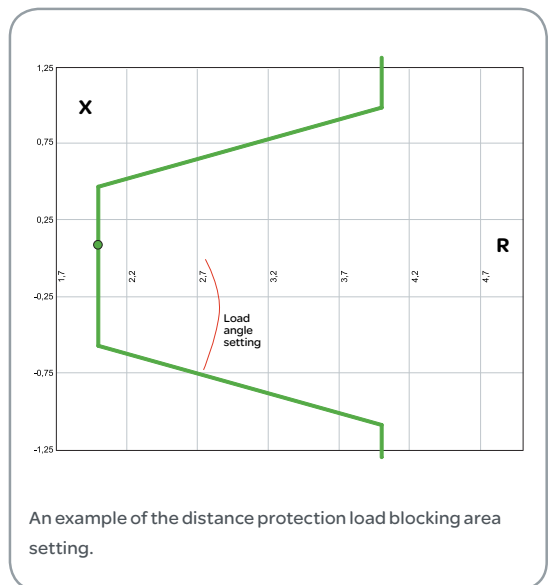
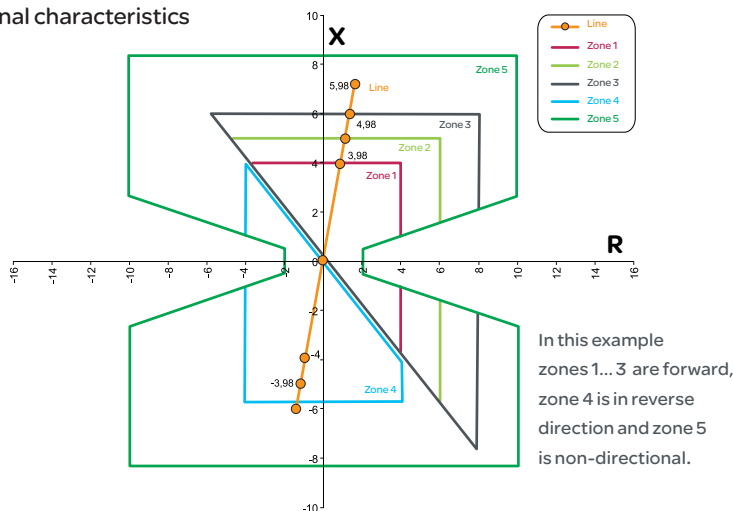

TYPICAL APPLICATION

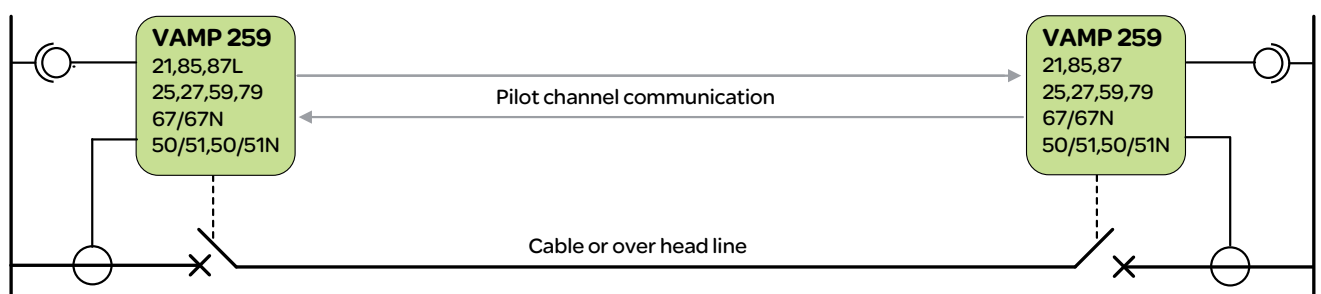

Line differential protection

Line differential protection $dI >$ / $87L$ provides high speed clearing for faults occurring at any point of the protected line or cable. Phase segregated protection is based on current (vector) differential. Combination of both phase and magnitude differential is used to determine operation. The differential element takes sampled values of the instantaneous current waveform as its local input and compares it with a corresponding current from the remote end. The measured signal is converted to magnitude and angle information for comparison. A dedicated communication channel, called a pilot channel, is used between two relays to exchange measured information.

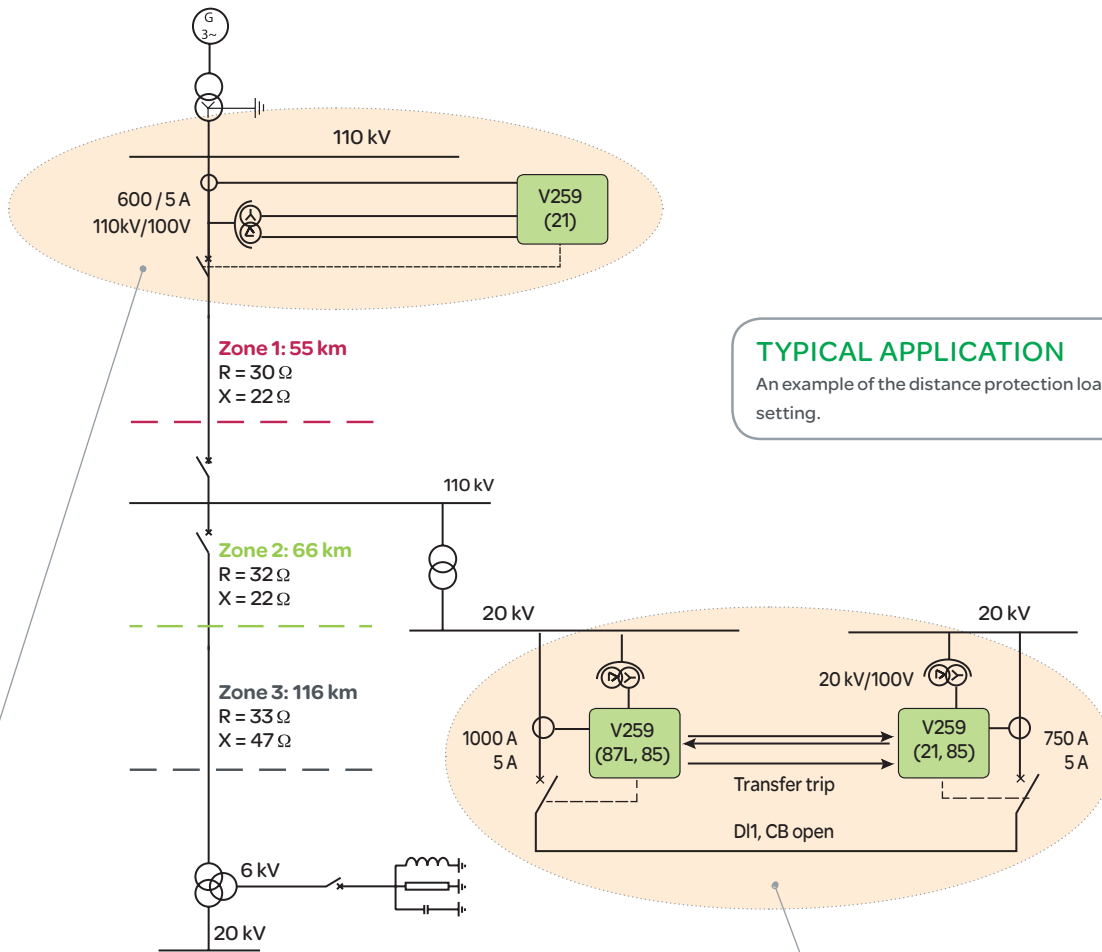

Impedance diagram

Distance protection zone settings: Zone 1...3 are in forward direction

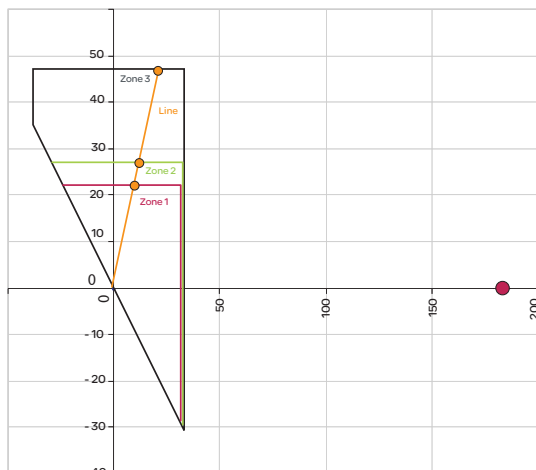

Line differential characteristics

The protection selectivity is adjusted by a biasing characteristics of the line differential protection.

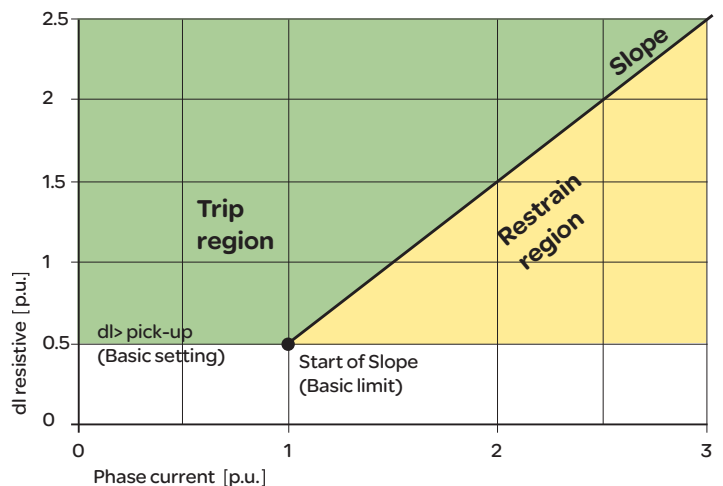

Arc flash protection

When time-grading or blocking based protection coordination principles are used, traditional protection systems may not provide fast enough protection of substation faults. Further, high- impedance type faults may cause prolonged operation times of earth-fault relays, leading to significant release of arc energy. These facts pose a considerable risk to human beings and economical assets. By applying a modern, high- speed arc flash protection system, the damage may be considerably reduced. Such an arc flash protection system is an optional feature that can be incorporated in all current measuring VAMP relays.

VAMP relays measure fault current and with the optional arc protection, also measure light via arc sensor channels which monitor the whole switchgear. Should an arcing fault occur in the switchgear the arc flash protection system provides extremely fast tripping of the circuit breaker. The fault will be prevented from spreading and quickly isolated, which may save human lives and valuable economical assets.

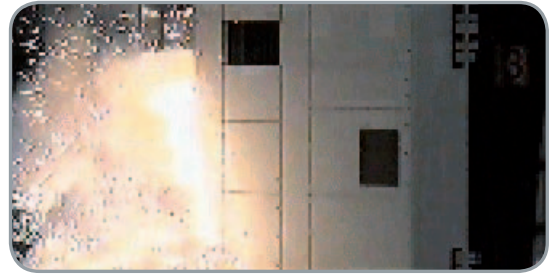

Traditional protection relay systems do not provide fast enough protection in arc-fault situations.



Communication

The Vamp 259 line manager can be equipped with an in-built Ethernet interface which can be used for either ModbusTCP, DNP 3.0 over TCP and IEC 61850 communication.

The IEC 61850 protocol can be used to read or write static data or to receive events sent spontaneously from the relay. In addition, the interface allows peer-to-peer communication between the relays - this is GOOSE communication. The IEC 61850 interface is configured with familiar, user-friendly Vampset software.

The IEC 61850 data model, data-sets, report control blocks and GOOSE communication are configured according to the requirements of the system configuration. Vampset is also used to produce ICD files, which may be needed for the substation RTU configuration.

The IEC 61850 solution is a native implementation which means that the IEC 61850 functionality is embedded in the software. Software requires only the main CPU of the relay – no additional processor or gateway module is needed.

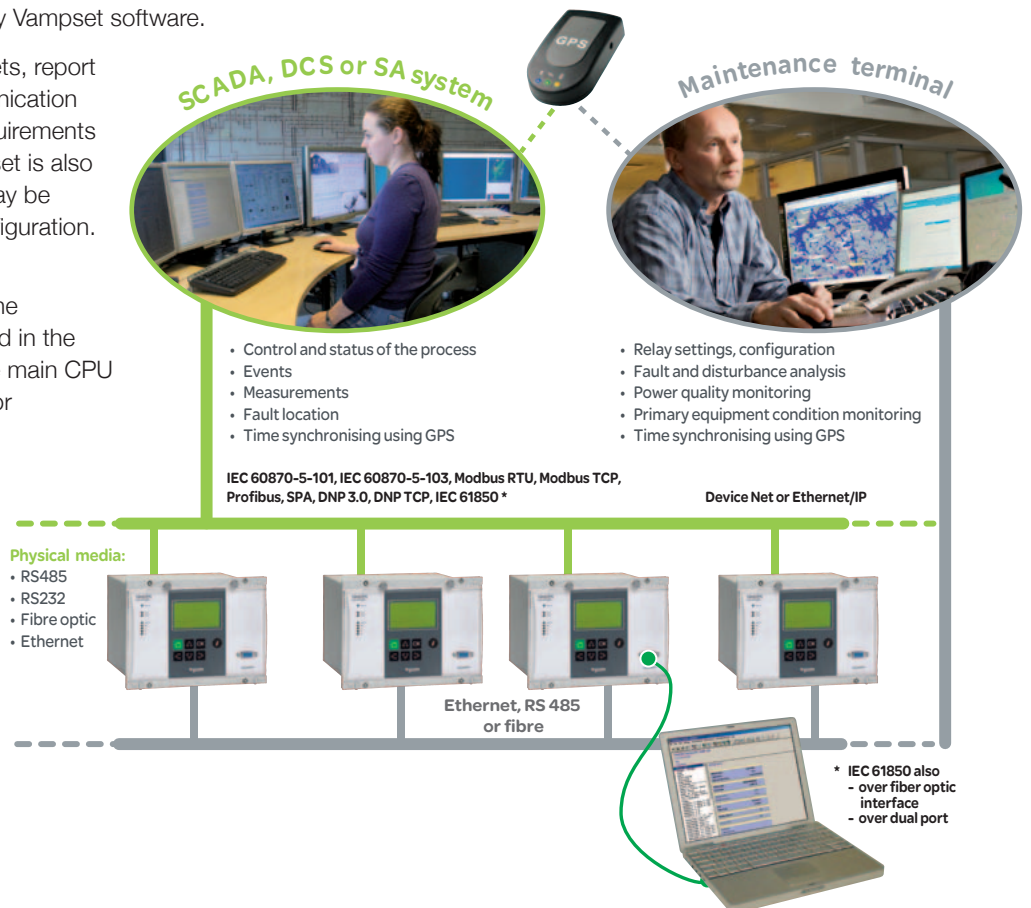

Protection stages

Type of fault	IEEE Device No.	IEC Symbol	Protection function/measurement
Line differential and distance	87L	dI>	Line differential protection
	21	Z<	Distance protection, 5 zones polygonal characteristic
	85		Optical pilot-wire receiver relay
Short circuit	50/51	3I >	Three-phase non-directional overcurrent, low-set stage, definite or inverse time
	50/51	3I >>	Three-phase non-directional overcurrent, high-set stage, definite time
	50/51	3I >>>	Three-phase non-directional overcurrent, high-set stage, definite time
	67N or 50N/51N	3I > →	Three-phase directional or non dir. o/c, low-set stage, definite or inverse time
	67N or 50N/51N	3I >> →	Three-phase directional or non dir. o/c, high-set stage, definite or inverse time
	67N or 50N/51N	3I >>> →	Three-phase directional or non dir. o/c, high-set stage, definite time
	67N or 50N/51N	3I >>>> →	Three-phase directional or non dir. o/c, high-set stage, definite time
Earth-fault	50N/51N	I ₀ >/ SEF	Non-directional earth-fault, low-set stage, sensitive, definite or inverse time
	50N/51N	I ₀ >>	Non-directional earth-fault, high-set stage, definite time
	50N/51N	I ₀ >>>	Non-directional earth-fault, high-set stage, definite time
	50N/51N	I ₀ >>>>	Non-directional earth-fault, high-set stage, definite time
	67N or 50N/51N	I _{0φ} >/ SEF	Directional or non dir. earth-fault, low-set stage, sensitive, definite or inverse time
	67N or 50N/51N	I _{0φ} >>	Directional or non dir. earth-fault, high-set stage, definite or inverse time
	67NT	I _{0T} >	Intermittent transient earth-fault
	59N	U ₀ >	Residual overvoltage, low-set stage
	59N	U ₀ >>	Residual overvoltage, high-set stage
Overload	49F	T >	Three-phase thermal overload (feeders & cables)
Voltage	59	3U >	Three-phase overvoltage, low-set stage
	59	3U >>	Three-phase overvoltage, high-set stage
	59	3U >>>	Three-phase overvoltage, high-set stage
	27	3U <	Three-phase undervoltage, low-set stage
	27	3U <<	Three-phase undervoltage, high-set stage
	27	3U <<<	Three-phase undervoltage, instantaneous stage
Arc flash protection	50ARC/50NARC	3 I _a / I ₀ >, L >	Electrical arc protection stage, point sensors, optional
Other functions	79	O → I	Auto-reclosure
	68	I ₂ >	Inrush and cold load detection
	46R	I ₂ /I ₁ >	Phase imbalance / discontinuity protection (broken conductor)
	37	3I <	Loss of load / under current protection
	86		Latched trip
	32	P <, P <<	Three-phase reverse power and underpower protection
	50BF	CBFP	Circuit breaker failure protection
	81H/81L	f ><, f >><<	Overfrequency and underfrequency protection
	81L	f <, f <<	Underfrequency protection
	81R	df/dt	Rate of change of frequency (ROCOF) protection
	25	df,dv	Synchrocheck
			Short circuit fault location
			8 Programmable stages
		DR	Disturbance recorder

Measurements and other functionalities

Type of measurement	IEC Symbol	Protection function/measurement
Primary current	3I	Three-phase current
	I_0	Neutral current
	I_2	Current imbalance
	IL	Average and maximum demand current
Primary voltage	3U	Three-phase and line voltage
	U_0	Residual voltage
	U_2	Voltage unbalance
	Xfault	Short-circuit fault reactance
Frequency	f	System frequency
Power	P	Active power
	Q	Reactive power
	S	Apparent power
Energy	E+, E-	Active Energy, exported / imported
	Eq+, Eq-	Reactive Energy, exported / imported
Power factor	PF	Power factor
Harmonics	I	2nd to 15th and THD of phase currents
	U	2nd to 15th and THD of measured voltages
Voltage sags / swells	U	Voltage sags / swells
Control		
Digital inputs		28 pcs of digital inputs (max),with DI19 & DI20
Output relays		8 pcs of trip relays
		5 pcs of alarm relays
Object status indication		Single line diagram, 8 objects
Local and remote control		6 pcs of controllable objects
Interlocking and logic		Configurable
Condition monitoring		
Trip circuit	TCS	Trip Circuit Supervision
	TCS	Trip Circuit Supervision with DI for T5
CT Supervision		CT Supervision
VT Supervision	60	VT Supervision/Fuse failure supervision
CB Wear		Breaker wear
Communication		IEC 60870-5-101
		IEC 60870-5-103
		Modbus TCP
		Modbus RTU
		Profibus DP
		DNP 3.0
		SPA-bus communication
		IEC 61850
		Human-Machine-Communication, display
		Human-Machine-Communication, PC
General functions		Selfsupervision
		Annunciating, event generating and value recording
		Measurement and parameter display
		Real time clock (Year, month, day, hour, minutes, seconds, milliseconds)

Connection diagrams

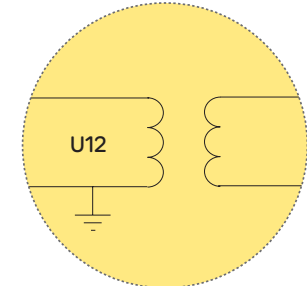
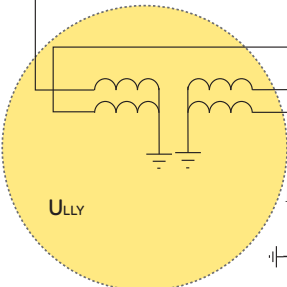
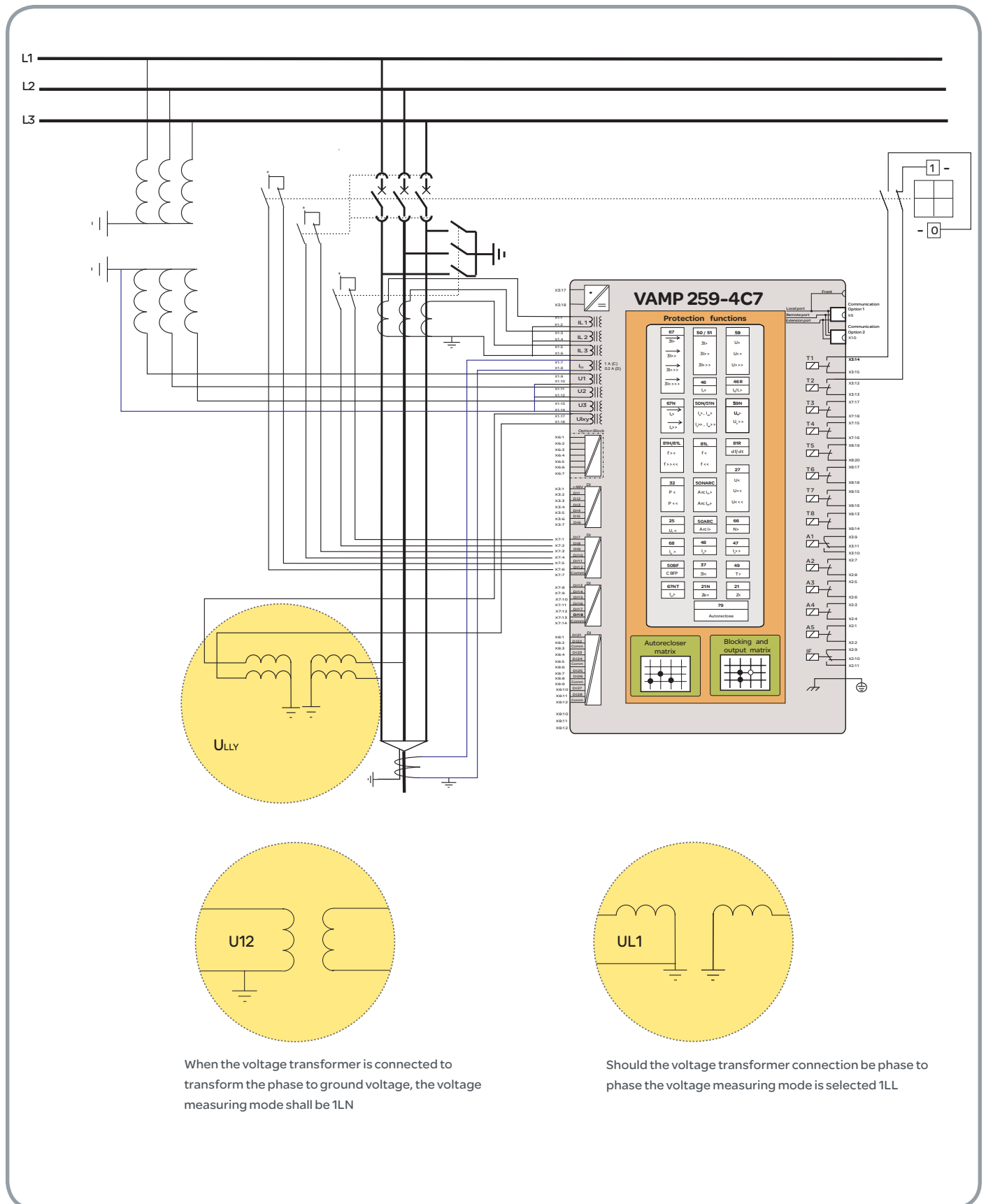

When the voltage transformer is connected to transform the phase to ground voltage, the voltage measuring mode shall be 1LN

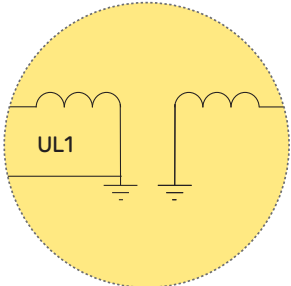

Should the voltage transformer connection be phase to phase the voltage measuring mode is selected 1LL

Dimensional drawings

PANEL MOUNTING VAMP 200 SERIES

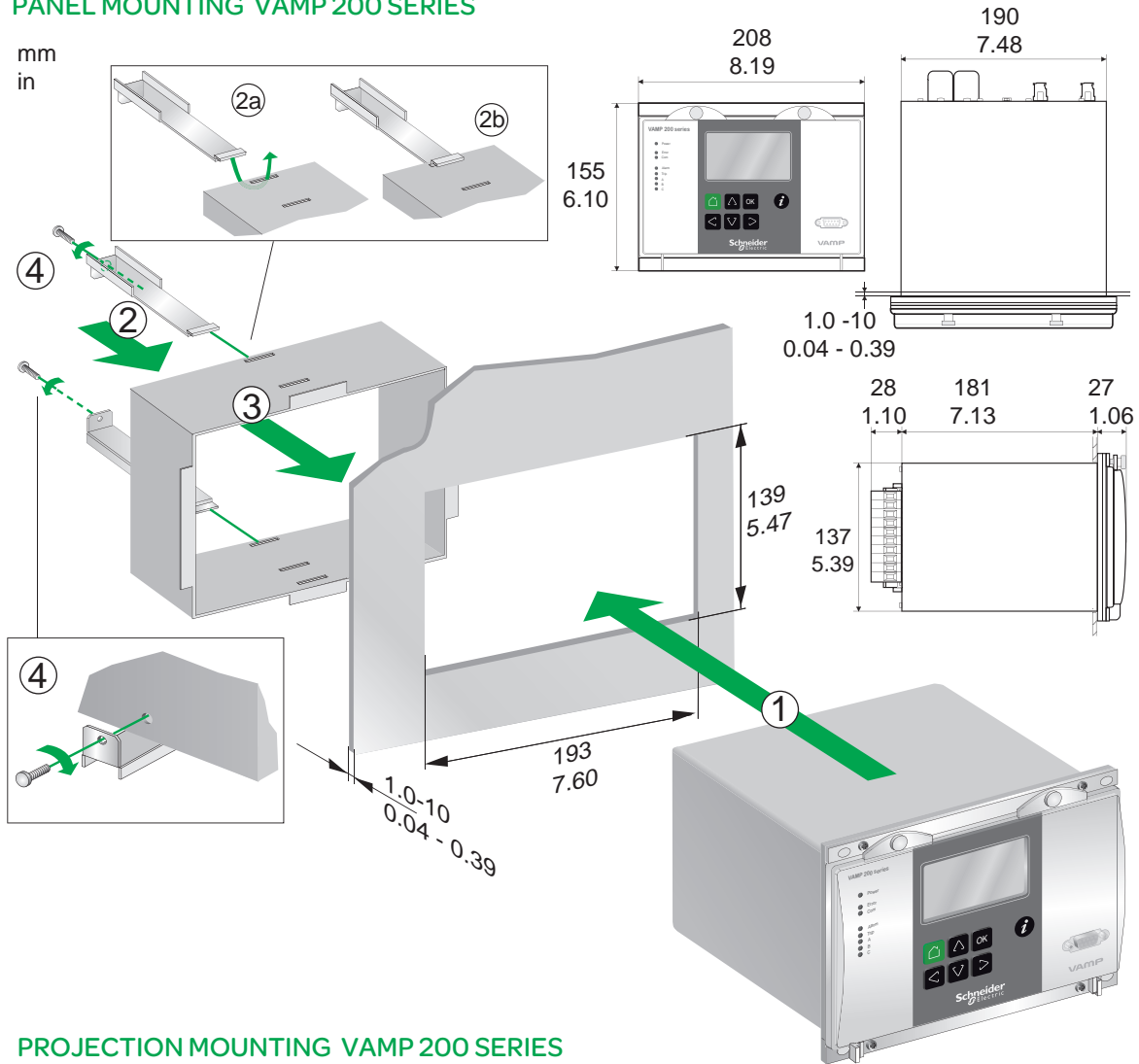

PROJECTION MOUNTING VAMP 200 SERIES

Projection	A	B	Fixing bracket
VYX076	40 mm / 1.57"	169 mm / 6.65"	Standard for 200 series
VYX077	60 mm / 2.36"	149 mm / 5.87"	Standard for 200 series
VYX233	100 mm / 3.94"	109 mm / 4.29"	2 x VYX199 needed

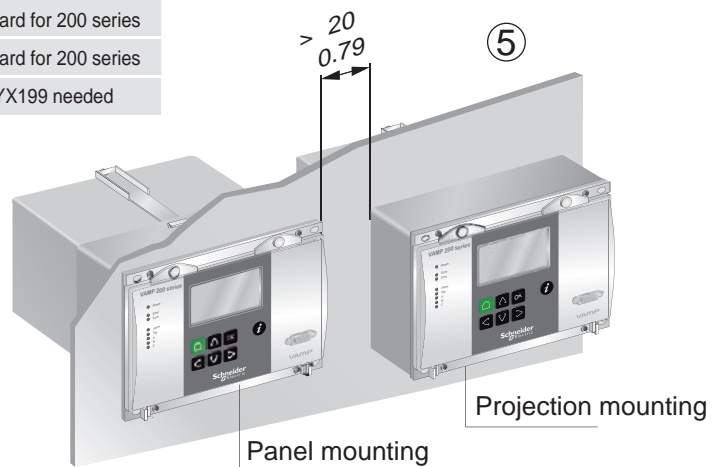
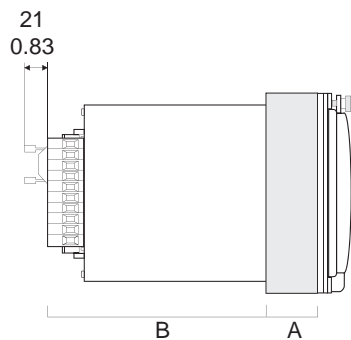

Order Codes

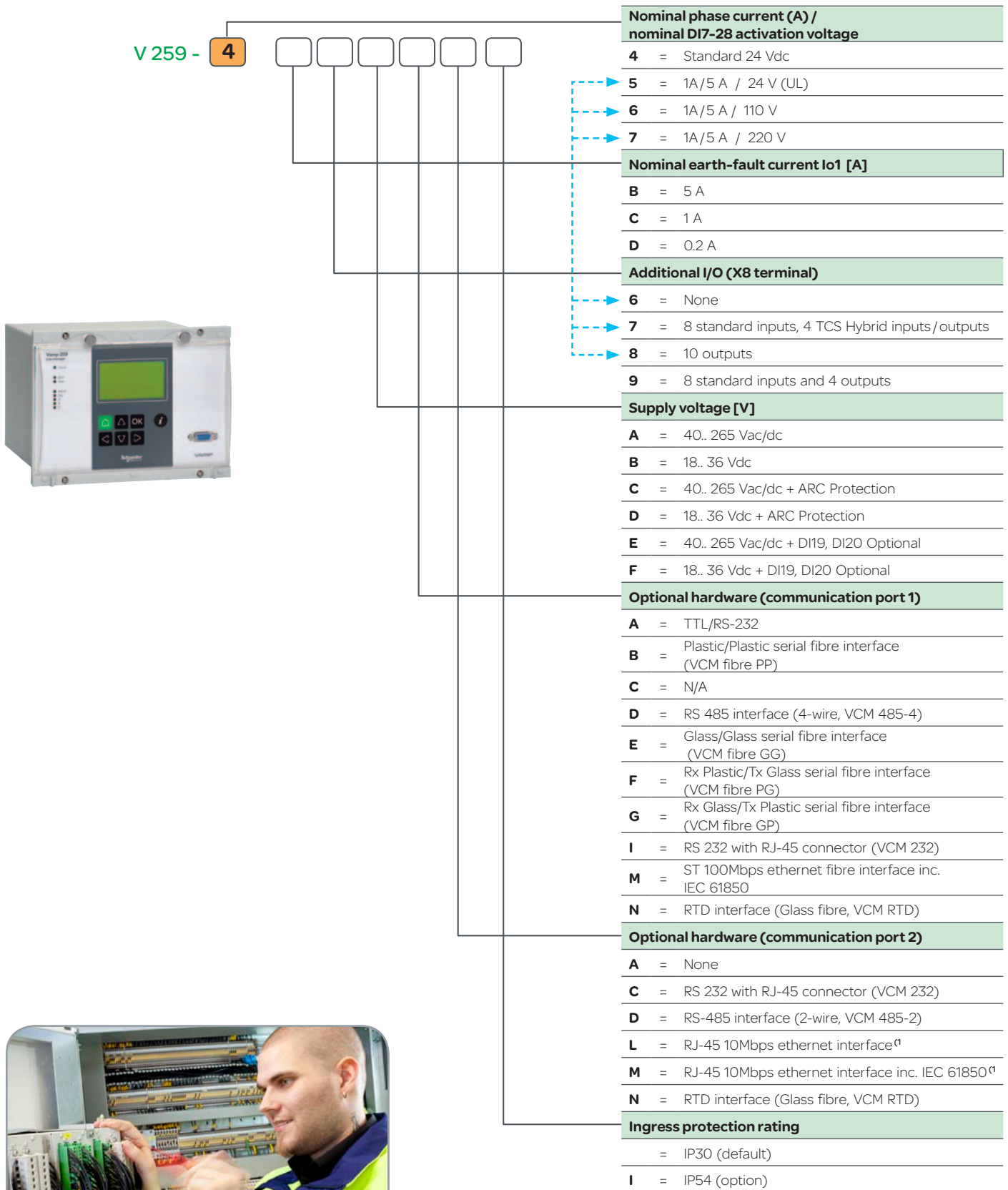

Note:

[†] NOT possible to order in combination with the following optional communication module 1: (M) ST 100 Mbps ethernet fibre interface with IEC 61850



ACCESSORIES

Order code	Explanation	Note
VEA3CGi	Ethernet adapter	
VPA3CG	Profibus DP fieldbus option board	
VSE001PP	Fiber optic Interface Module (plastic - plastic)	
VSE002	RS485 Interface Module	
VIO 12 AA	RTD Module, 12pcs RTD inputs, Optical Tx Communication (24-230 V ac/dc)	
VIO 12 AB	RTD Module, 12pcs RTD inputs, RS 485 Communication (24-230 V ac/dc)	
VIO 12 AC	RTD and mA output/input module, 12pcs RTD inputs, PTC, mA inputs/outputs, RS232, RS485 and Optical Tx/Rx Communication (24 Vdc)	
VIO 12 AD	RTD/mA Module, 12pcs RTD inputs, PTC, mA inputs/outputs, RS232, RS485 and Optical Tx/Rx Communication (48-230 V ac/dc)	
VX003-3	RS232 programming cable (Vampset, VEA 3CGi)	Cable length 3 m
3P025	USB to RS232 Adapter	
VX004-M3	TTL/RS232 converter cable (PLC, VEA 3CGi)	Cable length 3 m
VX007-F3	TTL/RS232 converter cable (VPA 3CG)	Cable length 3 m
VX048	RS232 (COM1=A) converter cable for MOXA TCF-90 (remote port)	Cable length 3 m
VX062	RS232 (COM1=A) converter cable for MOXA TCF-142-S-ST	Cable length 3 m
VX055	RJ45 (COM1=I or COM2=C) converter cable for MOXA TCF-90 (old Ldl>>>)	Cable length 3 m
VX056	RJ45 (COM1=I or COM2=C) converter cable for MOXA TCF-142-S-ST (old Ldl>>>)	Cable length 3 m
VX065	RJ45 (COM1=I or COM2=C) converter cable for MOXA TCF-90 (new Ldl>/Ldl>>)	Cable length 3 m
VX066	RJ45 (COM1=I or COM2=C) converter cable for MOXA TCF-142-S-ST (new Ldl>/Ldl>>)	Cable length 3 m
3P014	MOXA TCF-90	
3P022	MOXA TCF-142-S-ST	
3P032	WESTERMO ODW-720-F1	(Base module)
3P033	WESTERMO SLC20 (1310 nm)	Max. distance 20 km
3P034	WESTERMO SLC40 (1310 nm)	Max. Distance 40 km
3P035	WESTERMO SLC80 (1550 nm)	Max. distance 80 km
3P036	WESTERMO SLC120 (1550 nm)	Max. distance 120 km
VX063	RS232 (COM1=A) converter cable for WESTERMO ODW-720-F1 (remote port)	0
VX064	RJ45 (COM1=I or COM2=C) converter cable for WESTERMO ODW-720-F1	Cable length 3 m
VA 1 DA-6	Arc Sensor	Cable length 6 m
VAM 16D	External LED module	Disables rear local communication
VYX076	Raising Frame for 200-series	Height 40 mm
VYX077	Raising Frame for 200-series	Height 60 mm
VYX233	Raising Frame for 200-series	Height 100 mm
V200WAF	V200 wall assembly frame	

Available option-cards possible to be ordered separately:

Order code	Explanation
VCM 485-4	RS 485 interface (4 wire)
VCM 485-2	RS 485 interface (2 wire)
VCM FIBRE PP	Serial fibre interface (Plastic/Plastic)
VCM FIBRE GG	Serial fibre interface (Glass/Glass)
VCM FIBRE PG	Serial fibre interface (Plastic/Glass)
VCM FIBRE GP	Serial fibre interface (Glass/Plastic)
VCM 232	RS 232 with RJ45 connector
VCM RTD	RTD interface (Glass fibre)
VCM TTL	TTL/RS-232 interface



Technical Data, Tests and Environmental Conditions

Measuring circuitry

Rated phase current	5 A (configurable for CT secondaries 1 – 10 A)
Current measuring range	0...250 A
Thermal withstand	20 A (continuously)
	100 A (for 10 s), 500 A (for 1 s)
Burden	< 0.2 VA
Rated residual current (optional)	5A (configurable for CT secondaries 1 – 10 A)
Current measuring range	0...50 A
Thermal withstand	20 A (continuously)
	100 A (for 10 s), 500 A (for 1 s)
Burden	< 0.2 VA
Rated residual current	1 A (configurable for CT secondaries 0.1 – 10.0 A)
Current measuring range	0...10 A
Thermal withstand	4 A (continuously)
	20 A (for 10 s), 100 A (for 1 s)
Burden	< 0.1 VA
Rated residual current (optional)	0.2 A (configurable for CT secondaries 0.1-10.0 A)
Current measuring range	0...2 A
Thermal withstand	0.8 A (continuously)
	4 A (for 10 s), 20 A (for 1 s)
Burden	< 0.1 VA
Rated voltage Un	100 V (configurable for VT secondaries 50-120 V)
Voltage measuring range	0 – 160 V (100 V/110 V)
Continuous voltage withstand	250 V
Burden	< 0.5V A
Rated frequency fn	45 – 65 Hz
Frequency measuring range	16 – 75 Hz
Terminal block	Solid or stranded wire
Maximum wire dimension	4 mm ² (10-12 AWG)



Auxiliary voltage

	Type A (standard)	Type B (option)
Rated voltage Uaux	40 - 265 V ac/dc	18...36 V dc
	110/120/220/240 V	24 V dc
	48/60/110/125/220 V dc	
Power consumption	< 7 W (normal conditions)	
	< 15 W (output relays activated)	
Max. permitted interruption time	< 50 ms (110 V dc)	
Terminal block:	Phoenix MVSTBW or equivalent	
Maximum wire dimension	2.5 mm ² (13-14 AWG) :	

Package

Dimensions (W x H x D)	215 x 160 x 275 mm
Weight (Terminal, Package and Manual)	5.2 kg



Disturbance tests

Emission (EN 50081-1)	
Conducted (EN 55022B)	0.15 - 30 MHz
Emitted (CISPR 11)	30 - 1 000 MHz
Immunity (EN 50082-2)	
Static discharge (ESD) EN 61000-4-2, class III	6 kV contact discharge
	8 kV air discharge
Fast transients (EFT) EN 61000-4-4, class III	2 kV, 5/50 ns, 5 kHz, +/-
Surge EN, 61000-4-5, class III	1.2/50 μ s, common mode
	1 kV, 1.2/50 μ s, differential mode
Conducted HF field, EN 61000-4-6	0.15 - 80 MHz, 10 V
Emitted HF field, EN 61000-4-3	80 - 1000 MHz, 10 V/m
GSM test, ENV 50204	900 MHz, 10 V/m, pulse modulated

Test-voltages

Insulation test voltage (IEC 60255-5)	2 kV, 50 Hz, 1 min
Surge voltage (IEC 60255-5)	5 kV, 1.2/50 μ s, 0.5 J

Mechanical tests

Vibration (IEC 60255-21-1)	
10..60 Hz, amplitude 10.035 mm	
60..150 Hz, acceleration 0.5g	
sweep rate 1 octave/min	
20 periods in X-, Y- and Z axis direction	
Shock (IEC 60255-21-1)	
half sine, acceleration	5 g
duration	11 ms
3 shocks in X-, Y- and Z axis direction	

Environmental conditions

Operating temperature	-10...+55 ° C
Degree of protection (IEC 60529)	IP20
Transport and storage temperature	-40 to +70° C
Relative humidity	< 75% (1 year, average value),
	< 90% (30 days per year, no condensation permitted)



DEVICE TRACK RECORD

- Schneider Electric's VAMP Range specializes in arc flash protection relays for power systems.
- Schneider Electric VAMP's arc flash fault protection functionality enhances the safety of both people and property and has made Schneider Electric VAMP a pioneer in the field of arc flash protection with more than 10.000 VAMP arc flash systems and units with over 150.000 arc detecting sensors in service worldwide.
- Schneider Electric VAMP products meet the latest international standards and regulations.

Schneider Electric Industries SAS

35, rue Joseph Monier
CS 30323
F - 92506 Rueil Malmaison Cedex (France)
Tel.: +33 (0) 1 41 29 70 00
RCS Nanterre 954 503 439
Capital social 896 313 776 €
www.schneider-electric.com

As standards, specifications and designs change from time to time, please ask for confirmation of the information given in this publication.

Design: Schneider Electric Industries SAS - Sonovision
Photos: Schneider Electric Industries SAS
Printed in France

